

60" CLASS (59.5" DIAGONAL)

60PM4M

50" CLASS (49.9" DIAGONAL)

50PM4M

42" CLASS (41.6" DIAGONAL)

42PM4M

## Plasma Widescreen

## HD Capable Monitors



### NATIVE DISPLAY RESOLUTION

1366 x 768 WXGA (60PM4M)

1365 x 768 (50PM4M)

1024 x 768 XGA (42PM4M)

### CONTRAST RATIO

12,000:1 (60PM4M)

15,000:1 (42PM4M, 50PM4M)

### HIGH BRIGHTNESS

1200 cd/m<sup>2</sup> (60PM4M)

1500 cd/m<sup>2</sup> (42PM4M, 50PM4M)

### SPLIT ZOOM (self video wall)

Up to 4 x 4 matrix - adjusts for bezel width

### LG EXCLUSIVE XD ENGINE™

XD Contrast/XD Color/XD NR/MPEG NR

### IMAGE STICKING MINIMIZATION

Pixel orbiter, white wash, inversion and orbiter + inversion features

HDMI™ WITH HDCP

RS-232C CONTROL

OPTIONAL SPEAKERS AND STAND

CONVENIENT EXTERNAL SPEAKER OUT TERMINALS

MATTE BLACK BEZEL

2-YEAR LIMITED WARRANTY

(parts/labor)

# XD ENGINE

SHARPER  
BRIGHTER  
CLEARER

**ULTRA CONTRAST**  
AT A BLAZINGLY FAST 370 MILLION PIXELS PER SECOND, THE PROCESSOR USES A HISTOGRAM ANALYSIS TOOL TO CLARIFY THE IMAGE DATA ACCORDING TO SIGNAL BRIGHTNESS LEVELS.

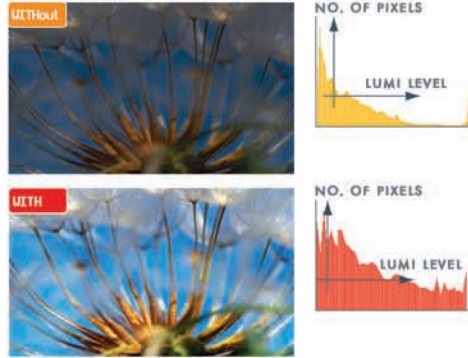

Dramatization

**DYNAMIC BLACK STRETCH**  
THE MINIMUM BLACK LEVEL OF AN IMAGE IS AUTOMATICALLY DETECTED AND ADJUSTED ACCORDING TO BRIGHTNESS.

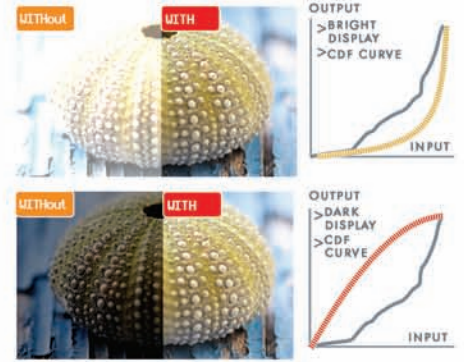

Dramatization

## OPTIONAL ACCESSORIES

### STANDS

**AP-42DM10B** (black)  
30.0"W x 12.1"H x 11.54"D  
15.7 lbs.

**AP-50DM11B** (black)  
31.88"W x 12.1"H x 12.4"D  
15.7 lbs.



42/50PM4M

**AP-60DM40** (black)  
45.7"W x 15.5"H x 16.3"D  
47.3 lbs.



60PM4M

### SPEAKERS (8Ω)

**AP-42SM40** (black)  
6.1"W x 25.6"H x 2.4"D each  
4.32 lbs. each

**AP-50SM40** (black)  
6.8"W x 29.3"H x 2.3"D each  
5.47 lbs. each



**AP-60SM40** (black)  
5.3"W x 34.8"H x 3.9"D each  
5.51 lbs. each



### AT-A-GLANCE

|        | SPEAKERS  | STANDS     |
|--------|-----------|------------|
| 42PM4M | AP-42SM40 | AP-42DM10B |
| 50PM4M | AP-50SM40 | AP-50DM11B |
| 60PM4M | AP-60SM40 | AP-60DM40  |

### PWMT300

FIXED OR TILTING WALL MOUNT

- Fits most LG 23" to 60" flat panel screens\*\*
- Easily expandable adapter brackets and wall plate
- Adjustable tilt of +15°/-5° for viewing flexibility
- Intuitive design for easy installation
- Security and standard screws included
- Portrait/landscape capability with mounting hole patterns up to 41"(W) and 26.37" H
- For mounting to wood studs, solid concrete, or cinder block only

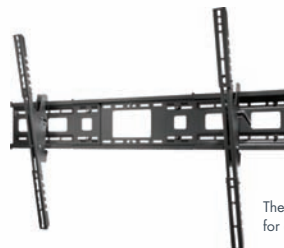

The PWMT300 is a Peerless® mount that is available for order at LG Electronics USA, Inc.

### CLEAR SCREEN

USING THE NOISE FILTER INSIDE THE XD ENGINE CHIP, THE IMAGE IS ANALYZED FOR TEMPORAL AND SPATIAL INFORMATION TO REDUCE MPEG NOISE.

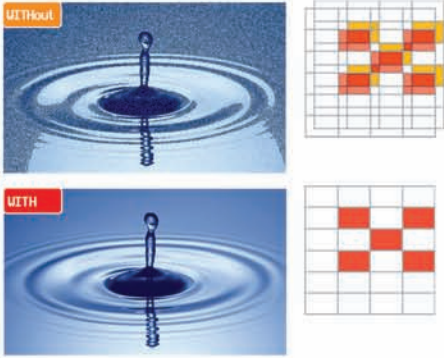

Dramatization

### ADVANCED VIVID COLOR

COLORS THAT ARE SENSITIVE TO THE HUMAN EYE ARE OPTIMIZED TO THE NEAREST TRUE COLOR BY THE SELECTIVE COLOR CONTROL.

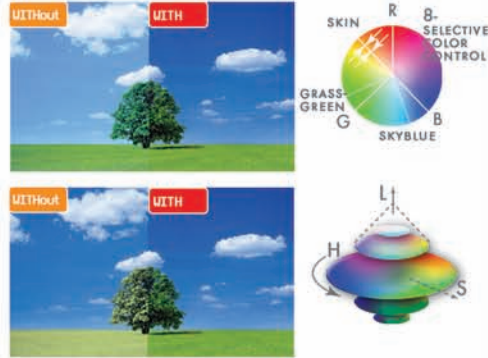

Dramatization

### INTELLIGENT EDGE CONTROL

EDGE LINES ARE EMPHASIZED BY IMPROVING THE TRANSITION FROM THE BACKGROUND TO THE MAIN OBJECT.

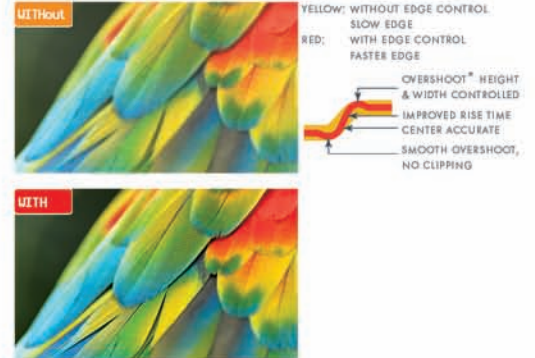

Dramatization

# DIMENSIONS

## 60PM4M

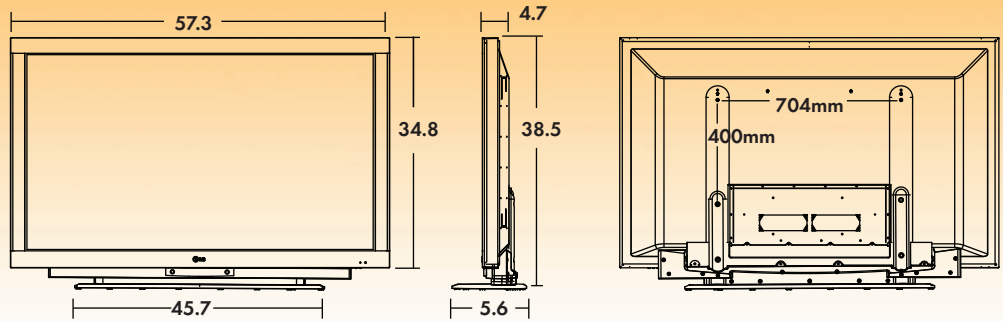

## 50PM4M

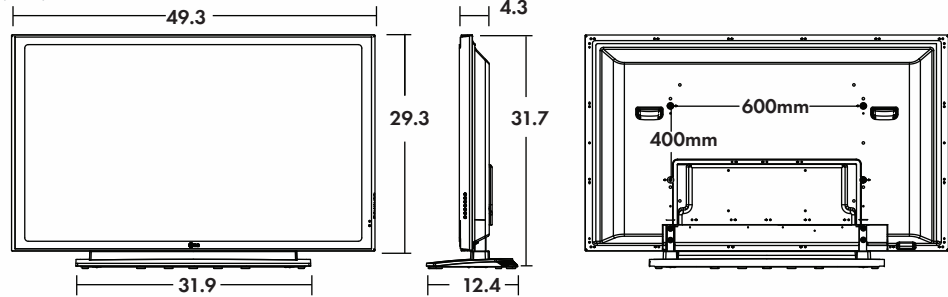

## 42PM4M

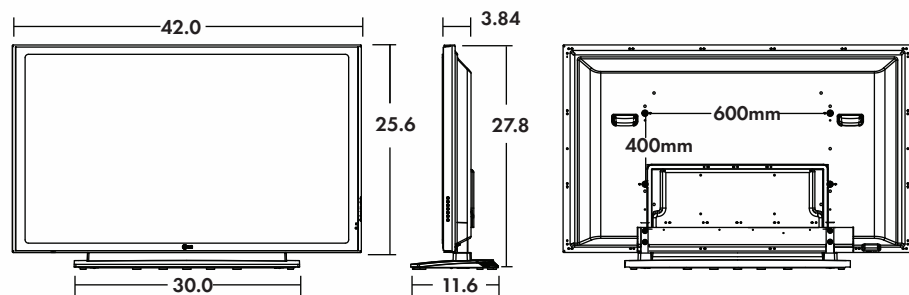

### REAR JACK PACK PANEL

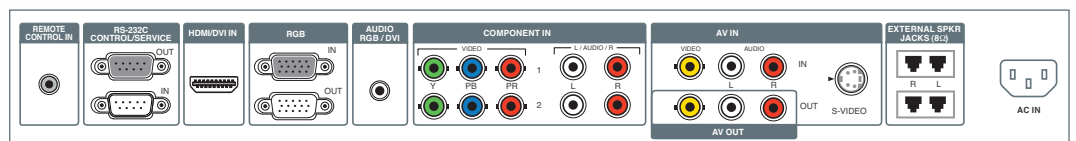

### AKB33871403 REMOTE CONTROL



60PM4M | 60" CLASS (59.5" DIAGONAL)  
 50PM4M | 50" CLASS (49.9" DIAGONAL)  
 42PM4M | 42" CLASS (41.6" DIAGONAL)

SPECIFICATIONS

**SPECIFICATIONS**

|                             |   |
|-----------------------------|---|
| PDP Panel Type              | 42" (42PM4M), 50" (50PM4M), 60" (60PM4M)                              |
| Display Area                | 41.6" (42PM4M), 49.9" (50PM4M), 59.5" (60PM4M)                        |
| Aspect Ratio                | 16:9  |
| Native Display Resolution   | 1024 × 768 (XGA) (42")<br>1365 × 768 (50")<br>1366 × 768 (WXGA) (60") |
| Pixels (H×V×3)              | 2,359,296 (42")<br>3,144,960 (50")<br>3,147,264 (60")                 |
| Brightness                  | 1500 cd/m <sup>2</sup> (42"/50")<br>1200 cd/m <sup>2</sup> (60")      |
| Contrast Ratio              | 15,000:1 (42"/50")<br>12,000:1 (60")                                  |
| Viewing Angle (H × V)       | 160 × 160   |
| Color Reproduction (R,G,B)  | 10 bits   |
| Filter Type                 | Glass Filter  |
| Image Sticking Minimization | White Wash, Pixel Orbiter, Inversion                                  |
| Lifetime                    | Approx. 60,000 hours to half brightness (MTBF)                        |

**VIDEO**

|   |   |
|---|---|
| Max. Input Res.                             | 1600×1200@60Hz (Analog)<br>1280×1024@60Hz (Digital)                           |
| Recommended Resolution (Analog/Digital)     | 1024 × 768 @ 60Hz (42")<br>1360 × 768 @ 60Hz (50")<br>1366 × 768 @ 60Hz (60") |
| H-Scanning Frequency                        | 30 ~ 83kHz (Analog/Digital)   |
| V-Scanning Frequency                        | 56 ~ 75Hz   |
| Pixel Frequency                             | 16.5 MHz (D-Sub)/135 MHz (HDMI/DVI)   |
| Sync Compatibility                          | Separate/Composite/SOG  |
| Video Input                                 | RGB Analog/Digital  |
| PSM (3 presets+2 User Defined)              | Dynamic/Standard/Mild/User1/User2   |
| CSM (3 presets+1 User Defined)              | Warm/Normal/Cool/User   |
| DLTI (Digital Luminance Transient Improver) | Yes   |
| DCTI (Digital Color Transient Improver)     | Yes   |
| Color Temperature Control                   | Cool/Medium/Warm/User   |
| Cinema 3:2/2:2 Pull Down Mode               | Yes   |
| Aspect Ratio Correction                     | Spectacle/Full/Original/4:3/16:9/14:9/<br>Zoom 1/Zoom 2                       |

**CABINET**

|  |  |
|--|--|
| Speakers/Table Stand (Optional)        | Yes  |
| Cabinet Color                          | Matte Black  |
| Monitor Dimensions (W×H×D)             | 42" × 25.6" × 3.8" (42PM4M)<br>49.3" × 29.3" × 4.3" (50PM4M)<br>57.3" × 34.8" × 4.7" (60PM4M)      |
| with Optional Stand & Speakers (W×H×D) | 48.3" × 27.8" × 11.6" (42PM4M)<br>55.6" × 31.7" × 12.4" (50PM4M)<br>67.7" × 38.5" × 16.3" (60PM4M) |
| Monitor Carton Dimensions (W×H×D)      | 45.4" × 29.4" × 14.4" (42PM4M)<br>52.9" × 35.4" × 18.2" (50PM4M)<br>62" × 41.2" × 18.2" (60PM4M)   |
| Monitor Weight                         | 62.9 lbs.<br>85.5 lbs.<br>130.5 lbs.   |
| Packed Weight                          | 77.4 lbs.<br>101.4 lbs.<br>148.8 lbs.  |
| VESA™ Standard Mount Interface         | Yes, 600mm×400mm (Screw M6) (42/50")<br>No, 704mm×400mm (Screw M8) (60")                           |

**ACCESSORIES**

|                      |   |
|----------------------|---|
| Supplied Accessories | Owner's Manual/Power Cord (6 foot)/<br>Remote Control (AKB33871403) |
| Optional Stand       | AP-42DM10B (42PM4M)<br>AP-50DM11B (50PM4M)<br>AP-60DM40 (60PM4M)    |
| Optional Speakers    | AP-42SM40 (42PM4M)<br>AP-50SM40 (50PM4M)<br>AP-60SM40 (60PM4M)      |

|     |                 |        |
|-----|-----------------|--------|
| UPC | 7 19192 17186 2 | 42PM4M |
|     | 7 19192 17187 9 | 50PM4M |
|     | 7 19192 17265 4 | 60PM4M |

**POWER**

|   |   |
|---|---|
| Power Consumption                       | 330 Watts (42")<br>450 Watts (50")<br>650 Watts (60") |
| Energy Star® Compliant                  | No  |
| Power Supply                            | 100-240V~, 50/60Hz                                    |
| Power Switch Type                       | Tact Type (In Local Key)                              |
| Power Saving Stand-by/Suspend           | 1W (RGB)/4W (HDMI/DVI)                                |
| DPM Off (Dynamic Power Mgmt) Switch Off | 1W (RGB)/4W (HDMI/DVI)<br>1W                          |

**REAR INPUTS**

|                                       |   |
|---------------------------------------|---|
| Component Video & Audio L/R In        | 2 Hi-Res (BNC)                                      |
| PC Input via 15-pin female mini D-Sub | 1 (RGB)   |
| Composite Video & Audio L/R In        | 1 (BNC)   |
| Audio In (RGB/DVI with Adapter)       | 1   |
| HDTV Formats                          | 720p/1080i  |
| PC Formats                            | Auto Scaling to XGA                                 |
| HDMI with HDCP (DVI with Adapter)     | 1   |
| RS-232C In (9-pin male D-Sub)         | 1 (Service/Control)                                 |
| S-Video In                            | 1 (S-Video has priority but there is no input mode) |
| Remote Control In (IR)                | 1   |
| Discrete IR Input                     | Yes   |

**REAR OUTPUTS**

|                                      |                                  |
|--------------------------------------|----------------------------------|
| PC Output via 15-pin male mini D-Sub | 1 (RGB)                          |
| Composite Video & Audio L/R Out      | 1 (BNC)                          |
| RS-232C Out (9-pin female D-Sub)     | 1                                |
| External Speaker Out Terminals       | Yes (with Amplifier Integration) |

**AUDIO**

|                           |   |
|---------------------------|---|
| SSM (Sound Status Memory) | Surround MAX/Flat/Music/Movie/Sports/User |
| AVL (Auto Volume Limiter) | Yes (On/Off)                              |
| Audio Output Power        | 20W (10W × 2)                             |
| Sound Balance (On/Off)    | Yes (for use with optional speakers)      |

**SPECIAL FEATURES**

|  |   |
|--|---|
| Temperature Sensor                       | Yes   |
| Split Zoom (Self Video Wall) Matrix      | 1 × 2, 2 × 2, 3 × 3, 4 × 4 (Row × Column)   |
| Split Zoom (Self Video Wall) Adjustments | Horizontal and Vertical, Video adjusts for bezel width                                      |
| Tiling Save & Load                       | Yes   |
| Vertical Display Mode Menu Rotation      | No  |
| Source Selections                        | HDMI/DVI, RGB, Component 1 or 2, Composite  |
| Brightness/Contrast Control              | Yes   |
| Color Control                            | Warm, Normal, Cool, and User Control (RGB)  |
| Tracking (analog signal)                 | Auto Config. or Manual Config. (Clock, Phase)   |
| Set-up Language Menu Selection           | English/French/Spanish/Korean/Italian/<br>German/Portuguese/Japanese/Chinese                |
| ISM (Image Sticking Minimization)        | Normal/White Wash/Pixel Orbiter/Inversion/Orb+Inv<br>(Pixel Orbiter and Inversion combined) |
| XD (LG's picture improving technology)   | XD Contrast/XD Color/XD NR/MPEG NR  |
| Advanced Screen Color Functions          | Cinema, Black Level (Auto, High, Low)   |
| Time Functions                           | Clock/On Time/Off Time (switches to standby)  |
| Special                                  | Auto Adjust/OSD Lock  |
| Audio Mute                               | Yes (select from Remote Control)  |
| Sleep Timer Button (on Remote)           | Set timer to switch from On to Off  |
| Auto Power/Source Memory                 | Yes   |
| WUXGA Compatible (1920×1080p)            | No (Not compatible with 1080p Source Input)   |
| Child Lock                               | Yes   |
| Special Features                         | IP-Cast™ Capable (incl. LST-4100B mounting holes)   |

**STANDARD (CERTIFICATION)**

|                |                      |
|----------------|----------------------|
| Safety         | UL/c-UL/CB scheme    |
| EMC            | FCC Class "B"/CE/MIC |
| RoHS compliant | Yes                  |

**SERVICE/LIMITED WARRANTY**

|                  |                    |
|------------------|--------------------|
| Limited Warranty | 2 Year Parts/Labor |
|------------------|--------------------|

**OPERATING ENVIRONMENTS**

|                           |                               |
|---------------------------|-------------------------------|
| Storage Temperature Range | -4°F to 140°F (-20°C to 60°C) |
| Storage Humidity Range    | 10% to 90% RH                 |
| Altitude                  | Up to 6,561 feet (2,000 m)    |
| Operating Temperature     | 32°F to 140°F (0°C to 60°C)   |
| Operating Humidity Range  | 20% to 80% RH                 |

www.LGcommercial.com



LG Electronics U.S.A., Inc.  
 Commercial Products Division  
 2000 Millbrook Drive,  
 Lincolnshire, IL 60069

Customer Service: 888.865.3026  
 Contact your LG regional sales representative:  
 B2B: 800.897.8788  
 IT: 800.321.5501  
 Hospitality: 800.228.1236  
 Channel Markets: 800.897.8871

SPEC\_60.50.42PM4M\_LG070824\_PL



All screen images are simulated. Dimensions and weights are approximate. Design, specifications, and features subject to change without notice.

© Copyright 2008 LG Electronics USA, Inc. All Rights Reserved. LG Life's Good is a registered trademark of LG Corp.

XD Engine is a trademark of LG Electronics USA, Inc. VESA is a registered trademark of Video Electronics Standards Association. ENERGY STAR is a registered trademark of the U.S. Environmental Protection Agency.

All other product and brand names are trademarks or registered trademarks of their respective companies.

Printed in the USA. July 2008